

AVK Combi-flange

for PE, uPVC and Bi-PVC

Series 05

Mounting instruction

1.
Bi-PVC (DN 250-300) + PE



uPVC



2.

A

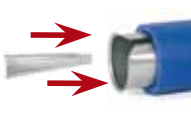

B



C



3. Glidemiddel / Gleitmittel / Grease / Fett / Vet / Grasa / Graisse Alimentaire



4.



5.

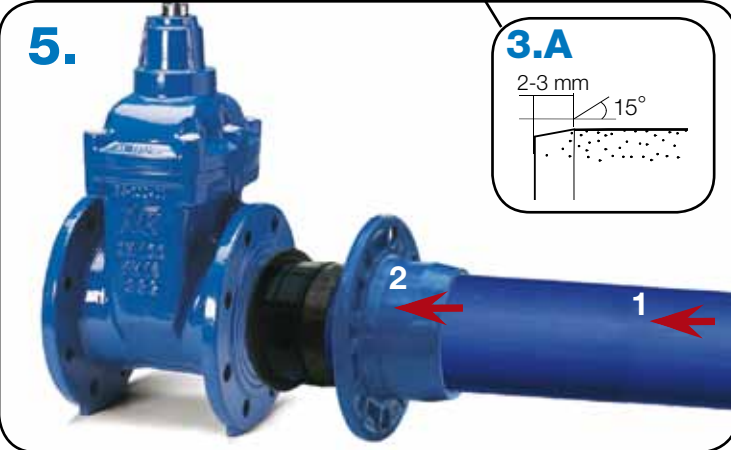

3.A

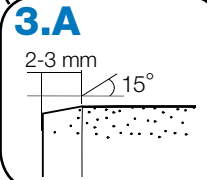

6.

6A

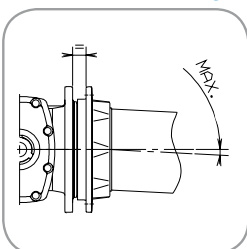

6B

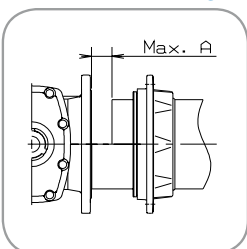

6C

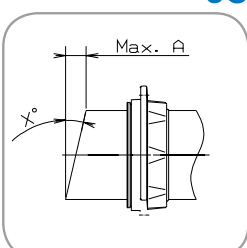

6D

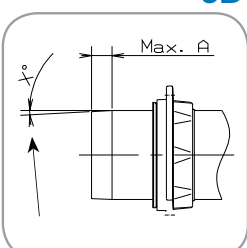

Non-tensile: ±3.5° max 16 bar

Tensile (<=ø250mm): ±3.5° max 16 bar

Tensile (ø280-315mm): ±1.5° max 10 bar

7.

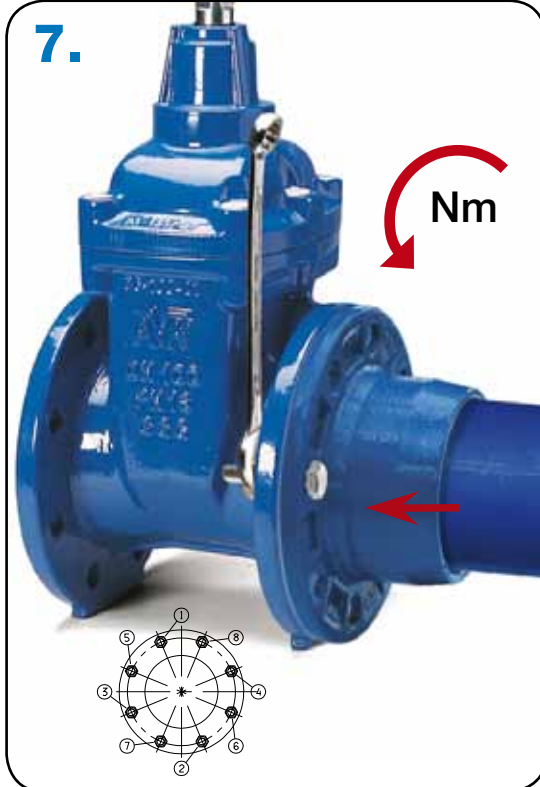

Nm

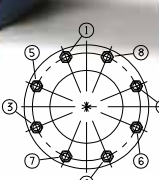



AVK Combi-flange for PE, uPVC and Bi-PVC

Part No.: XXXXXXXXXX



CHECK

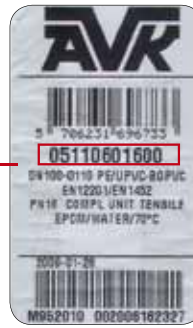

AVK International A/S
Bizonvej 1, Skovby · 8464 Galten
Tel.: +45 87 54 21 00
www.avkvalves.com

DN/ext. dia	A	Bolts PN 10	Bolts PN 16	Nm
50/63	20	4 of M16x60	4 of M16x60	40
60/75	20	4 of M16x60	4 of M16x60	40
65/75	20	4 of M16x60	4 of M16x60	40
80/90	20	8 of M16x60	8 of M16x60	40
100/110	20	8 of M16x60	8 of M16x60	40
125/125	20	8 of M16x60	8 of M16x60	40
125/140	20	8 of M16x60	8 of M16x60	40
150/160	30	8 of M20x60	8 of M20x60	80
200/200	30	8 of M20x60	12 of M20x60	80
200/225	30	8 of M20x60	12 of M20x60	80
250/250	30	12 of M20x60	12 of M24x60	120
250/280	35	12 of M20x65	12 of M24x65	120
300/315	35	12 of M20x70	12 of M24x70	120

Note: For DN 200/ø225 to DN 300/ø315 use minimum 2 bolts to pull assembly together with an additional length of 30 mm.

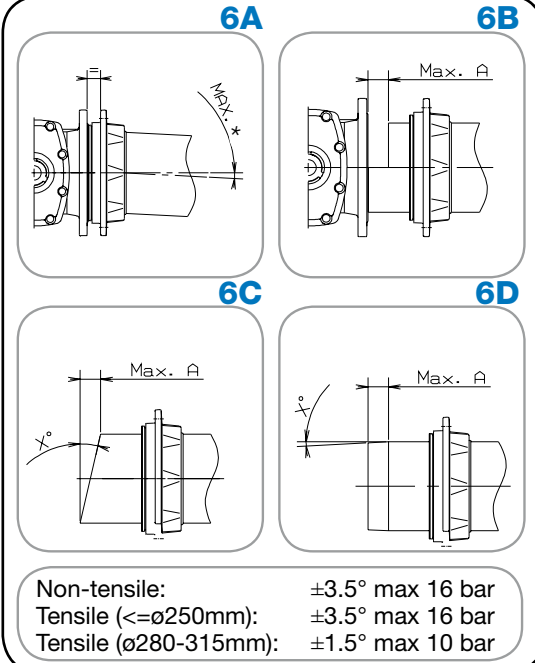

TENSILE RESISTANT

DN	Pipe ext Ø	PN	AVK Item no. Flange with tensile gasket	VVS-No.	RSK-No.	LVI-No.	AVK Item no.* Flange with tensile gasket	NRF No.*
50	63	10/16	05-050-601600	14 3302.050	1141622	1965123	05-050-160638203	2081465
60	63	10/16	05-063-601600	14 3302.060	1141623	1965124		
65	75	10/16	05-075-601600	14 3302.065	1141624	1965125	05-075-160758203	2081466
80	90	10/16	05-090-601600	14 3302.080	1141625	1965126	05-090-160908203	2081467
100	110	10/16	05-110-601600	14 3302.100	1141626	1965127	05-110-161108203	2081468
125	125	10/16	05-125-601600	14 3302.125	1141627	1965128	05-125-161258203	2081469
125	140	10/16	05-140-601600	14 3302.126	1141628	1965129	05-140-161408203	2081471
150	160	10/16	05-160-601600	14 3302.150	1141629	1965130	05-160-161608203	2081472
200	200	10	05-200-600600	14 3303.200	1141630	1965131	05-200-162008303	2081473
200	200	16	05-200-601600	14 3302.200	1141631	1965132	05-200-162008203	2081474
200	225	10	05-225-600600	14 3303.201	1141632	1965133	05-225-162258303	2081475
200	225	16	05-225-601600	14 3302.201	1141633	1965134	05-225-162258203	2081476
250	250	10	05-250-600600	14 3303.250	1141634	1965135	05-250-162508303	2081477
250	250	16	05-250-601600	14 3302.250	1141635	1965136	05-250-162508203	2081478
250	280	10	05-280-600600	14 3303.251	1141636	1965137	05-280-162808303	2081479
250	280	16	05-280-601600	14 3302.251	1141637	1965138	05-280-162808203	2081481
300	315	10	05-315-600600	14 3303.300	1141638	1965139	05-315-163158303	2081482
300	315	16	05-315-601600	14 3302.300	1141639	1965140	05-315-163158203	2081483

NON-TENSILE RESISTANT

DN	Pipe ext Ø	PN	AVK Item no. Flange with non-tensile gasket	VVS-No.	RSK-No.	LVI-No.	AVK Item no.* Flange with non-tensile gasket	NRF No.*
50	63	10/16	05-050-621600	14 3300.050	1141640	1965141	05-050-760638203	2081446
60	63	10/16	05-063-621600	14 3300.060	1141641	1965142		
65	75	10/16	05-075-621600	14 3300.065	1141642	1965143	05-075-760758203	2081447
80	90	10/16	05-090-621600	14 3300.080	1141643	1965144	05-090-760908203	2081448
100	110	10/16	05-110-621600	14 3300.100	1141644	1965145	05-110-761108203	2081449
125	125	10/16	05-125-621600	14 3300.125	1141645	1965146	05-125-761258203	2081451
125	140	10/16	05-140-621600	14 3300.126	1141646	1965147	05-140-761408203	2081452
150	160	10/16	05-160-621600	14 3300.150	1141647	1965148	05-160-761608203	2081453
200	200	10	05-200-620600	14 3301.200	1141648	1965149	05-200-762008303	2081454
200	200	16	05-200-621600	14 3300.200	1141649	1965150	05-200-762008203	2081455
200	225	10	05-225-620600	14 3301.201	1141650	1965151	05-225-762258303	2081456
200	225	16	05-225-621600	14 3300.201	1141651	1965152	05-225-762258203	2081457
250	250	10	05-250-620600	14 3301.250	1141652	1965153	05-250-762508303	2081458
250	250	16	05-250-621600	14 3300.250	1141653	1965154	05-250-762508203	2081459
250	280	10	05-280-620600	14 3301.251	1141654	1965155	05-280-762808303	2081461
250	280	16	05-280-621600	14 3300.251	1141655	1965156	05-280-762808203	2081462
300	315	10	05-315-620600	14 3301.300	1141656	1965157	05-315-763158303	2081463
300	315	16	05-315-621600	14 3300.300	1141657	1965158	05-315-763158203	2081464

* Kit incl. bolts